

Refrigerator-Freezer OPERATING INSTRUCTIONS



Cleaning Instruction - Important!

It is strongly recommended to use only lukewarm water and a soft cloth when cleaning. Cleaning agents can cause cracking to the plastic components of your refrigerator.



R600a



WARNING

Fire/Flammable refrigerant
No Touch Except Service Specialist

R600a Refrigerant Warning

- This appliance contains a small quantity of R600a refrigerant which is flammable.
- During transportation and installation, ensure that the tubing of the refrigerant circuit is not damaged.
- Leaking refrigerant can ignite and may damage the eyes.
- In the event any damage does occur, avoid exposure to open fires and any device which creates a spark. Disconnect the appliance from the mains power. Thoroughly ventilate the room in which the appliance is located for several minutes.
- The room for installing the appliance must be at least 1 cubic metre per 8 grams of refrigerant.
- The refrigerant quantity contained in this appliance is noted on the Rating Label of the appliance.

- Maintenance work shall only be carried out at workshop by well-trained maintenance worker.
- Please read this manual carefully and follow the information contained within. In particular, be sure to read the safety precautions before using this refrigerator.
- Be sure to receive your copy of the warranty from the retailer and confirm that the purchase date and retailer name are written on the warranty.
- Store this operating instructions manual and the warranty in a safe place.
- This refrigerator was manufactured for refrigerating and freezing of foods in general households. For commercial use, please use a commercial refrigerator-freezer.
- The photographs and illustrations contained in this manual are for the MR-LA635ER. While the capacity and dimensions of the MR-LA635ER are different from the MR-LA580ER, the operation is the same.
- The principal plastic components indicate the material name to facilitate recycling.
- Do not store explosive substances such as aerosol cans with a flammable propellant in this appliance.
- This appliance is intended to be used in household application only.
- WARNING - When positioning the appliance, ensure the supply cord is not trapped or damaged.
- WARNING - Do not locate multiple portable socket-outlets or portable power supplies at the rear of the appliance.
- WARNING - Just in case of having damaged the refrigerant circuit, do not use electric items or fire equipments near by, and open the window to ventilate the room. And contact the retail store at which you purchased it or the following MITSUBISHI SERVICE CENTRE.
- WARNING - Do not use mechanical devices or other means to accelerate the defrosting process, other than those recommended by the manufacturer.
- WARNING - Keep ventilation openings, in the appliance enclosure or in the built-in structure, clear of obstruction.
- The user manual should be handed over to any person who would use or handle the refrigerator whenever the refrigerator would be transferred to another location and delivered to a recycling plant.
- This refrigerator uses flammable foaming gas for insulation. Please deliver the unit to specialized industrial waste dealer when you do away it. Please follow the rules in your country.

SERIES MODEL

MR-LA580ER
MR-LA635ER





Contents

	Page	
Before use	For your safety, please be sure to follow these instructions	2-3
	From Installation to Operation	4-5
Operation	How to Use the Operation Panel	6-7
	Refrigerator Compartment	8-9
	Freezer Compartment	10
	Automatic Ice-Maker	11-12
	Rapid Cool	13
	Rapid Freeze	14
	Energy Saving Mode	15
	Performing Temperature Adjustment	16
Cleaning	How to remove and clean accessories	17-18
	How to maintain your automatic ice-maker	19-20
	Other Issues	21-24
	Troubleshooting	25-26
	Accessories	27

For your safety, please be sure to follow these instructions

The types of danger that can result from improper handling are explained in the sections below.

 WARNING	Mishandling can lead to serious injury or death.
 CAUTION	Mishandling can lead to bodily injury or loss of home and household contents.

■ The symbols illustrated below have the following meanings.

 Do not do	 Always follow instructions
 Do not get wet	 Always connect an earth wire
 CAUTION	 Always unplug electrical plug from socket

WARNING

When installing your unit



Do not install in an outdoor area where water can get on it or where there is a lot of moisture.

Due to insulation failure, it may cause an electric shock or fire. ➔ Page 4



Allow some space around the refrigerator.

If the refrigerant (gas) leaks, it can remain in the area and there's a risk that it may cause a fire or explosion. ➔ Page 4

To be prepared for an earthquake, affix to a strong wall or column.

Not doing so may cause injuries from the refrigerator toppling over. ➔ Page 5



Attach ground wire and earth leakage breakers when used in a humid or moist area.

(Please consult with the shop). ➔ Page 4

It may cause electric shock and the following ground connection may cause electric shock, explosion and fire.

- Water pipe/gas pipe.
- Telephone ground lines and lightning rod.

About the electrical outlet and electrical plug



Do not push the electrical plug with the back of the refrigerator. Do not damage the electrical cord.

If the plug is pressed by the refrigerator, or if the cord is bent, bundled, or a heavy object is placed on it, it can cause an electric shock or a fire.



Do not use damaged cords or plugs or loose outlets.

Using them can result in an electric shock or injury.

Do not remove the electrical plug by pulling the cord.

The cord can become damaged and can cause an electric shock or a fire.

Do not plug or unplug the electrical plug with wet hands.

It can cause an electric shock.



Use a dedicated outlet for the power supply that meets the rating specified on the rating label. (The rating label is located on the door-liner of the refrigerator compartment.)

Using an extension cord or plugging in too many power cords into the outlet can cause heat buildup or a fire. ➔ Page 4

Keep the electrical plug cord facing downwards and insert the plug in fully.

If it is plugged with the cord facing upward, extra pressure gets exerted on it which can cause it to heat up or ignite.



If the power cord is damaged.

If the power cord is damaged call Mitsubishi Electric Service Centre for a technician to replace power cord. The power cord should be designed for this model.

About the electrical outlet and electrical plug



Remove dust from the electrical plug.

Not doing so can cause a fire from insulation failure.



When replacing the interior refrigerator light or when taking care of the unit, pull out the electrical plug.

Not doing so can result in an electric shock or injury.

About using your refrigerator



Do not damage the refrigerant circuit (piping) of the refrigerator; do not drive in screws.

Because a flammable refrigerant (gas) is used, there is the danger of igniting or explosion.

Do not use electrical products inside the refrigerator unit.

If the refrigerant (gas) is leaking inside the unit, there is a risk that a spark from the electrical product's contact can be a source for ignition or explosion.

Do not store volatile products that can easily ignite. Benzine, cosmetics and hair styling products can be the cause for igniting fires and explosion.

Do not store pharmaceuticals or scientific test material. Anything that needs strict supervision must not be stored in a home-use refrigerator.

Do not place items on top of the refrigerator.

Items may drop from opening and closing the door and can cause injury.



Do not hang on the door or door handle and do not stand on the compartment drawer-type doors.

The refrigerator can topple over causing injury.



Do not forcefully place items on the glass shelf.

The glass can break and may cause injury.

Do not put your hands in the mechanical part of the automatic ice-maker (the upper part of the ice storage box).

Doing so will cause injury.

Do not use flammable sprays nearby.

A spark from the electrical contact can ignite and cause a fire.

- This appliance is not intended for use by young children or infirm persons unless they have been adequately supervised by a responsible person to ensure that they can use the appliance safely.
- Young children should be supervised to ensure that they do not play with the appliance.
- This appliance is not intended for use by persons (including children) with reduced physical, sensory or mental capabilities, or lack of experience and knowledge, unless they have been given supervision or instruction concerning use of the appliance by a person responsible for their safety. Children should be supervised to ensure that they do not play with the appliance.



When something abnormal or unusual occurs, turn off immediately and consult with “the store where you purchased the unit” or with a “Mitsubishi Electric repair counter.”

WARNING

About using your refrigerator



Do not do

Do not use in a shed or a garage.

If small animals damage the wiring, it can cause an electric shock or a fire.

Do not charge with any refrigerant other than our specification.

It may cause rupture, explosion, fire, etc. when using, repairing, disposal, etc.



Do not get wet

Do not put any vessels, jars, etc. that contain water on top of the refrigerator.

If water gets onto electrical parts, it will cause an electric shock or a fire.

Do not wash with water or spill liquid food items on the unit.

If water and food liquids get on the unit, it can cause an electric shock or a fire. If that happens, dry off immediately.



Always follow instructions

If you sense a gas leakage, do not touch the refrigerator. Open the window and ventilate the room.

A spark from the electrical contact can cause an explosion or a fire.

When the doors are opened or closed, beware not to hit any furniture.

The door or furniture may be damaged and cause any injury.

About Malfunctions / Long Term Care



Do not do

Do not take apart, repair or convert. Do not continue to use with damaged parts.

This can cause injury, an electric shock or a fire.



Always follow instructions

If the refrigerant circuit (piping) is damaged, do not touch the refrigerator, open the window and ventilate the room.

When the refrigerant circuit is damaged, please consult the store in which the unit was purchased.

If you will not be using the refrigerator for a long period of time, after pulling out the electrical plug, open the door and let the interior dry out.

If it is not dried adequately, the cooling unit may corrode causing the refrigerant (gas) to leak which can then cause the danger of ignition or explosion.



Always unplug electrical plug from socket

If something abnormal occurs (such as a burning smell), pull out the electrical plug and stop the refrigerator from running.

If it continues to run in an abnormal state, it can cause an electrical shock or a fire.

When Recycling



Always follow instructions

If there is a possible danger of a child getting trapped inside while the refrigerator is not in use, please pull off the door seal.

It is dangerous if the child gets shut inside.

When disposing of the unit, transfer it to the store that you purchased it or to the municipality.

If it is neglected and refrigerant (gas) leaks, ignition or an explosion may be caused due to heat from a fire.

CAUTION

Installing and Transporting



Always follow instructions

Install on a strong level floor and adjust the adjustable legs to fix firmly.

The refrigerator may move and cause injury.

→ Page 4~5

When carrying, use the handles made for carrying.

If other parts are held while carrying, it can cause injury. → Page 23

Be careful not to damage the floor or injure yourself when moving the refrigerator.

Lay a protective sheet on the floor and move the refrigerator slowly.



About using your refrigerator



Do not do

Do not force food items into the refrigerator. Do not use force to pull out shelves.

Food items may fall out, causing injury.

Do not store bottles in the freezer compartment.

If the center freezes and bottles crack, it will cause injury.

Do not place your hands or feet under the refrigerator.

You can get injured from something such as the steel plate.

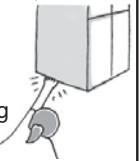

Do not eat food that has a bad smell or is discoloured.

Doing so may cause food poisoning or other illnesses.

Observe the following when opening and closing the doors.

- Do not open or close the doors when another person is touching the refrigerator.
- Do not put your fingers on the top edge of a drawer type door while closing it.
- Do not open or close the doors with excessive force. (Food may fall out and cause injury.)
- Be careful not to trap your fingers or any other part of your body.
- Be careful not hit a part of your body.
- Do not trap your feet with the bottom drawer. (Danger of your toes caught by the drawer.)



Not doing this may cause injury.

Do not touch foods or containers in the freezer compartment with wet hands.

Doing so can cause freezer burn.



CAUTION

Please pay enough attention when crushed the ice cube in ice storage corner.

It may cause injury.



Always follow instructions

Make sure that glass shelves or pockets are attached properly.

If insufficiently attached, it may fall out and may cause injury.

From Installation to Operation

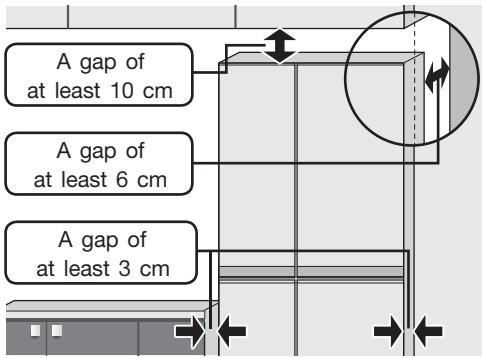

1 Installation

Install the refrigerator in:

- **A place with good ventilation that is not exposed to direct sunlight of hot air**
To prevent a diminishing in cooling performance and to reduce power costs.
- **A place with low humidity**
To prevent rusting, electric shock and fire.
- **A strong and level place**
To prevent vibration and noise, and ajar or tilting doors.
If the refrigerator supports sink easily into the floor material, lay a strong plate or board underneath. (To prevent deformation or discoloration due to the weight or heat.)
- **A place away from other devices**
To prevent noise or video interference with devices such as televisions.
- **A place with at least 3 cm of space beside the left and right of the refrigerator, 10 cm of space from the top and 6 cm from the back.**
To allow heat to dissipate from the sides, top and the back of the refrigerator.

Use in hot spring areas

Corrosion control treatment may be required for the refrigerant circuit (pipe) due to generation of corrosive gases. Contact the retail store where you purchased the refrigerator.

⚠ WARNING

Do not obstruct the refrigerator vents or the space around the refrigerator. If refrigerant leaks, it may accumulate and catch fire or explode.

Dedicated outlet that meets the specified rating.

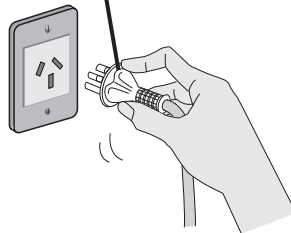

Turn on the power of the refrigerator as soon as possible.

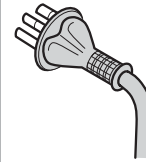

The refrigerator will not be damaged even if you turn on the power immediately after the installation.

2 Connect the power supply

*Connect power supply soon after installing the refrigerator

● Use a dedicated outlet

Use a dedicated outlet for the power supply that meets the rating specified on the rating label. (The rating label is located on the door-liner of the refrigerator compartment.)

⚠ WARNING

Using outlets that do not meet the specified rating or plugging in too many leads into a single socket can cause heat buildup or fire.

● The refrigerator will not be damaged even if the power is supplied soon after installation. It takes a while for the refrigerator to cool, therefore supply power as soon as possible.

● Electrical Connections

Make sure this unit is properly grounded.

- The refrigerator should always be plugged into its dedicated electrical outlet. This will provide the best performance and prevent electrical circuits from being overloaded and causing a fire. Make sure that the electrical outlet provides the proper voltage. Extension cords are not recommended.
- If your refrigerator is installed in a high humidity location, not only ground connection but also installation of the earth leakage breaker is recommended.
- If the power cord is damaged, purchase a new cord from MITSUBISHI ELECTRIC SERVICE CENTRE. Make sure that the power cord is designed for this model.
- If the power cord is damaged, call our MITSUBISHI ELECTRIC SERVICE CENTRE for the replacement, in order to avoid a hazard.

How to remove the energy label

- Remove the energy label carefully. A glue residue may remain, particularly if the label has been in place for a long period of time.
- Apply either Eucalyptus or Tea Tree oil directly on any residue.
- Do not allow the oil to run or drip onto plastic parts as it may cause the plastic to degrade and potentially crack over time.
- Allow the oil to sit for approximately 1-2 minutes, or until the glue residue has softened.
- Wipe off with a damp cloth.
- If any residue remains, repeat the above process.
- Rinse with clear water.
- Dry thoroughly.

The outside of the refrigerator and the rotating partition get hot.

Heat radiation causes the temperature to rise to about 50°C to 60°C when operation is first started, and during the summer. The rotating partition may get hot when heated by the heater.



Rotating partition

Cooling takes time after turning on the refrigerator.

- Wait until the refrigerator has fully cooled before storing non-cooled food or ice cream.
- Do not open the doors more than necessary, and close them as soon as possible.

When making ice for the first time

In summer it may take more than 24 hours before the first batch of ice is made.

Bottom front of refrigerator

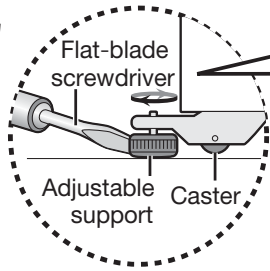
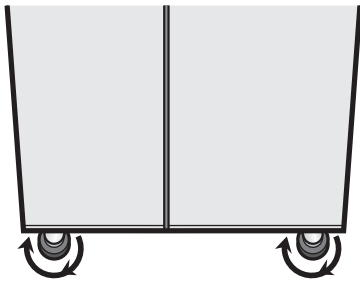

Insert the blade of the screwdriver
Turn the adjustable supports
in the arrow direction until
they touch the floor.

CAUTION
If the supports are not
adjusted properly, the
refrigerator may move
and cause injury.

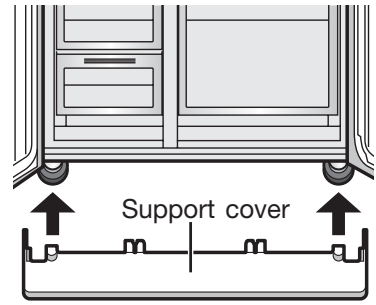

3 Adjustment and anchoring

(To prevent vibration, noise, movement, and ajar doors)

Turn the adjustable supports until they touch the floor and the front casters are raised from the floor.

- Preventing ajar doors
- Adjusting a tilted door or unevenness

Adjust the supports to make the refrigerator level.

If the front of the refrigerator is slightly raised, the doors are easier to close.

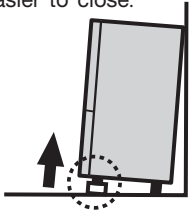

Readjust the adjustable supports as shown in the figures below.

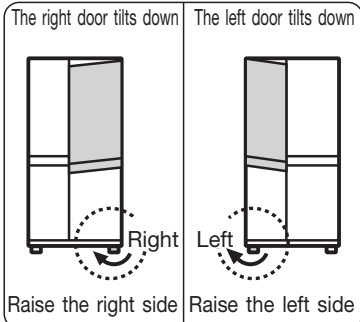

If the installation location is not level or the supports sink after a few days due to the weight of the food, the doors may appear tilted. Readjust the supports.

- If the door is still tilted after adjustment of the supports

When installing the refrigerator in the corner of a room, one of the rear supports may sink, causing the refrigerator to tilt. If this happens, use a caster support or strong board for adjustment. (Normally, use a board with a thickness of about 2 to 3 mm.)

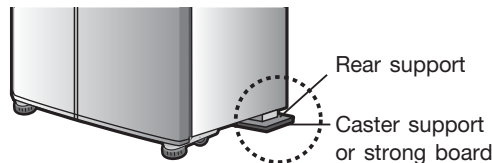

4 Support cover

The support cover is stored inside the refrigerator compartment at shipment.

- Installing the support cover

While the freezer door is open

Insert the support cover horizontally and fully, until it makes contact with the rear side.

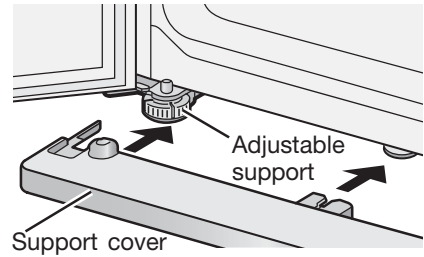

The support covers are designed for the left and right adjustable supports respectively.

The operation noise gets louder immediately after installation.

Immediately after installation, when the weather is hot, the doors are frequently opened or closed, or any similar situation; the operation noise will get louder because the refrigerator will switch to high-speed operation to cool with high power.

Prepare for earthquakes.

Thread 2 strong belts through the hand-holds on the top rear of the refrigerator and anchor them to a strong location, such as wall or post.

WARNING
The refrigerator may tip over and cause injury.

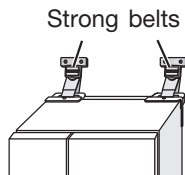

Do not damage the refrigerant circuit (pipes) or drive screws into it.

Although R600a refrigerants are combustible, the refrigerant circuit is hermetically sealed and normally leaks will not occur.

WARNING

- Should the refrigerant circuit be damaged:
1. Do not use flames or electrical appliances nearby.
 2. Open the windows to fully ventilate the room.

Then, contact the retail store where you purchased the refrigerator.

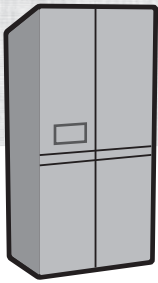

How to Use the Operation Panel

Touching  will cause the operable icons to light up.

To save power, all displays other than  are usually turned off (it turns off if there is no operation after 30 seconds).



When operating, be sure to touch the buttons with your fingers.

ECO icon mark

When ENERGY SAVING is set, and the refrigerator is running efficiently, ECO icon mark will light up. → Page 15

Child Safety Lock → Page 21

Detail Setting

Touch  to go to compartment selection;

Touch  to go to temperature settings.

Example: When setting the refrigerator compartment to "MID"

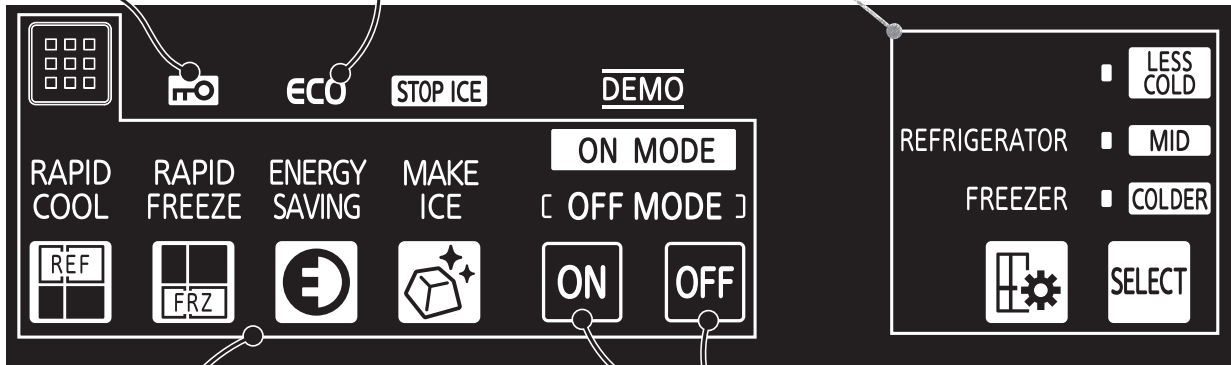
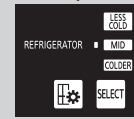

When turning ON or OFF settings, touch one of these.

Touch an icon to display its setting details.



If you touch the operation panel, icons will be displayed. You can select the setting that you prefer.



Rapid Cool

To cool a large amount of food quickly in refrigerator compartment.



Rapid Freeze

To freeze a large amount of food quickly in freezer compartment.



Energy Saving Mode

To save power.



Ice making

To start or stop ice making.

Operation Example (When Setting RAPID COOL)

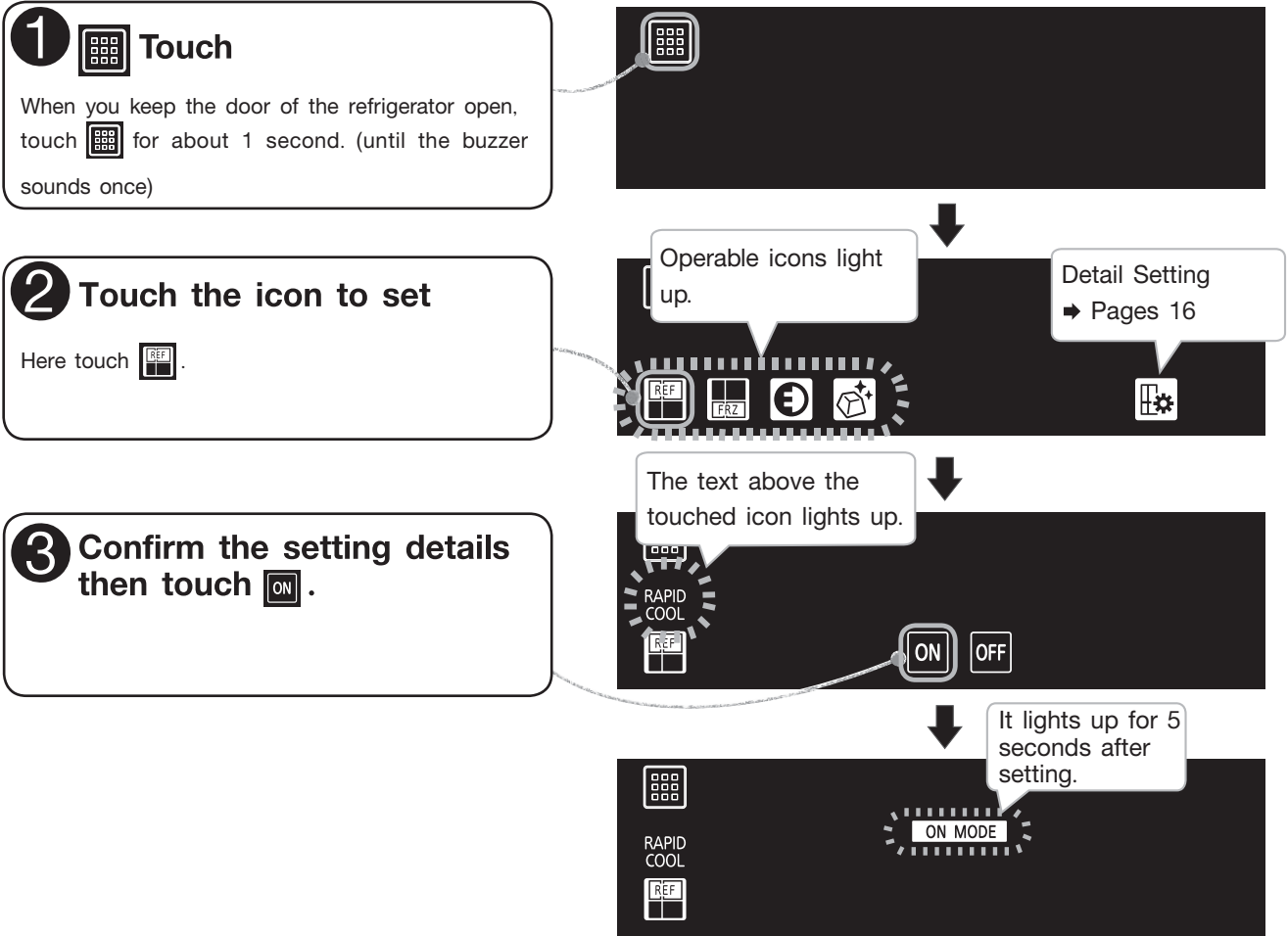

In ② and ③, touching returns the display to the previous state.

To Cancel the Setting

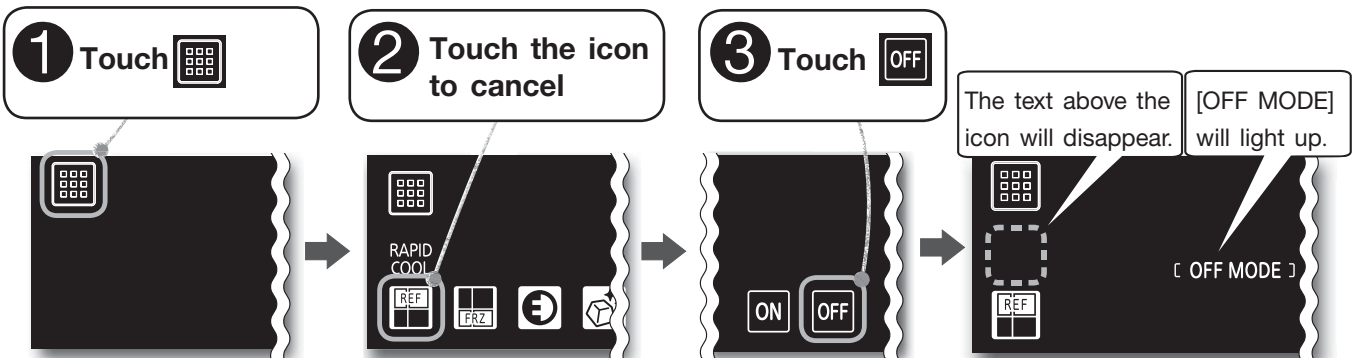

In the following cases, the display may not change even when you touch it.

The operation panel or your fingers are wet or dirty.



You are wearing gloves or have sticking plaster on your finger.



The interval between touches is too short. (Pressing repeatedly may cause a misdetection)

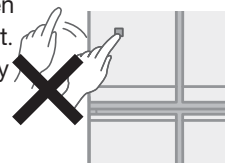

- Wipe the moisture and dirt off your fingers. Perform operations with your hands. After you have touched an icon, confirm that the display has changed before touching again.
- The response may vary, depending on the surrounding temperature, humidity, the health condition of the person who operates it, and the operating condition of neighboring electric appliances.

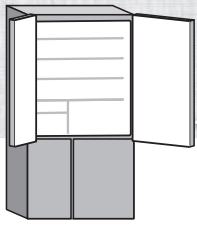

Refrigerator Compartment

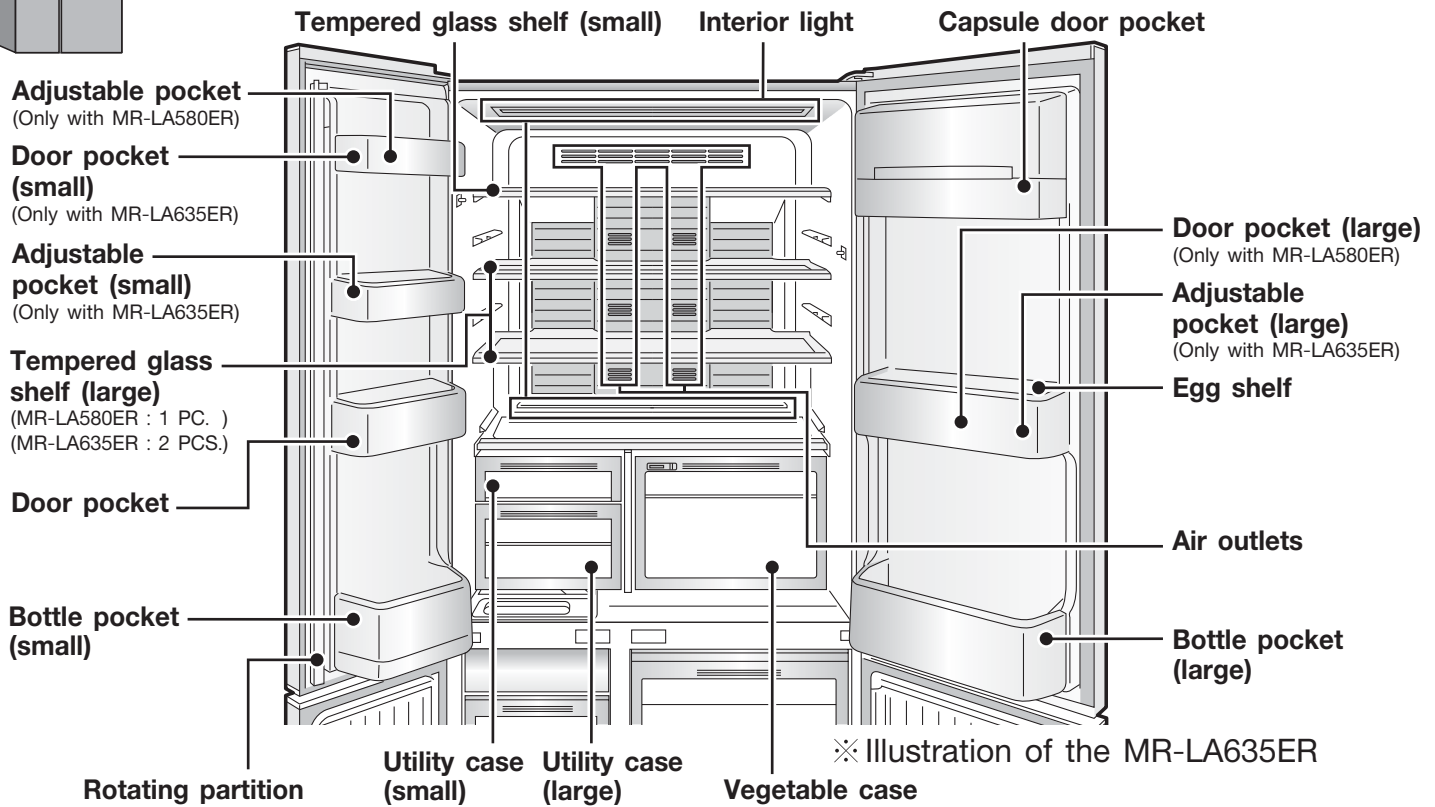

Do not close the door while the rotating partition is turned up to the front.

If you open or close the doors rapidly with force, the rotating partition may open to the front. Open and close the doors slowly. (Otherwise damage may result.)

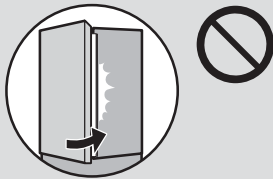

Tempered glass shelf

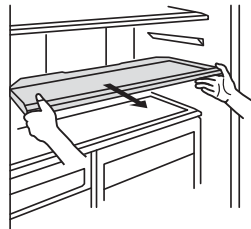

While cleaning the refrigerator, be sure to remove the shelves (made of tempered glass) and put them back properly. Or else, the falling or smashed shelf could cause personal injuries.

Vegetable case

Humidity of vegetable compartment can be adjusted.

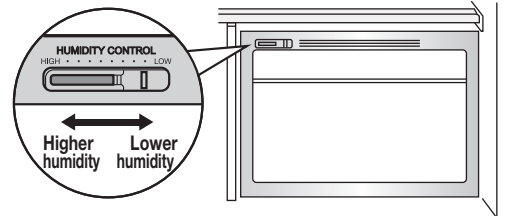

* If food with a high level of moisture is placed near the air outlets, it may freeze. ► Page 25

■ If the door alarm sounds ► Page 22

Wrap food that have strong odors thoroughly before storage

Food that transfers odors easily

Shallot, dried fish, fermented foods, beef, sardines, kimchi, etc.

• A slight odor may remain.

Food to which odors are easily transferred

Puddings, ice cream, potato salad, rice, bread, milk, cake, ice, etc.

• A slight odor may remain.

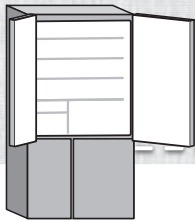

Refrigerator Compartment (Continued)

Adjustable pockets

Adjustable to 2 positions

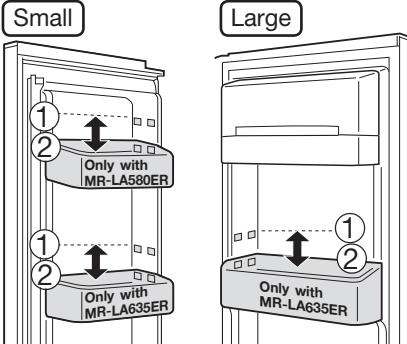

■ Relocate the pockets

► Page 16

Egg shelf

Egg holder or small organizing compartments. By turning it over it can be used either way.

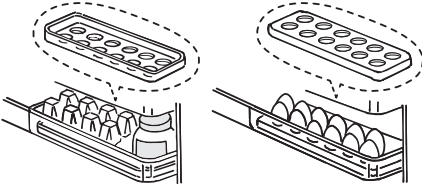

Do not leave food hanging over shelves or pockets. Do not place glass bottles that cannot fit all the way to the bottom at the front of the bottle pocket.

The bottle may keep a door ajar, or the bottle may break.



Do not attach a case that you purchased separately onto the outside of a pocket.

It may keep a door ajar and reduce the cooling performance, or food may fall and cause an injury or damage to a case or lid.



Do not close the door while food is in front of the Vegetable case or Utility cases.



Fully stow away the cases.

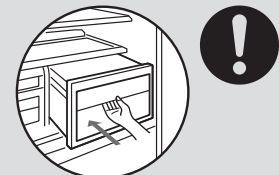

Tips for Energy Saving



ECO

Set Energy Saving Mode for automatic energy saving operation. ► Page 15

Idea for energy saving

Keep space between items in the refrigerator.

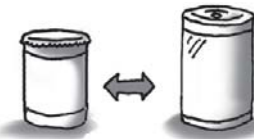

Put items on the top shelf if you wish to cool sufficiently.

Helpful storage hints

Allow hot food to cool before storing.



Avoid opening the door frequently or leaving the door open for a long time.



Be sure not to catch food items, plastic bags, power cord, etc. in the door when you close it.

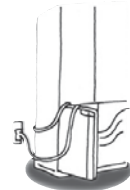

Wipe



wrap

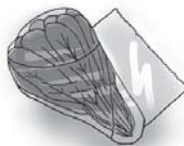

Frost or dew build-up that may cause decline in cooling ability as a result of even the slightest door opening. Water may also drip off.

Before use

Operation

Cleaning

When in trouble

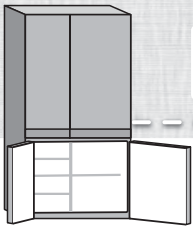

Freezer Compartment

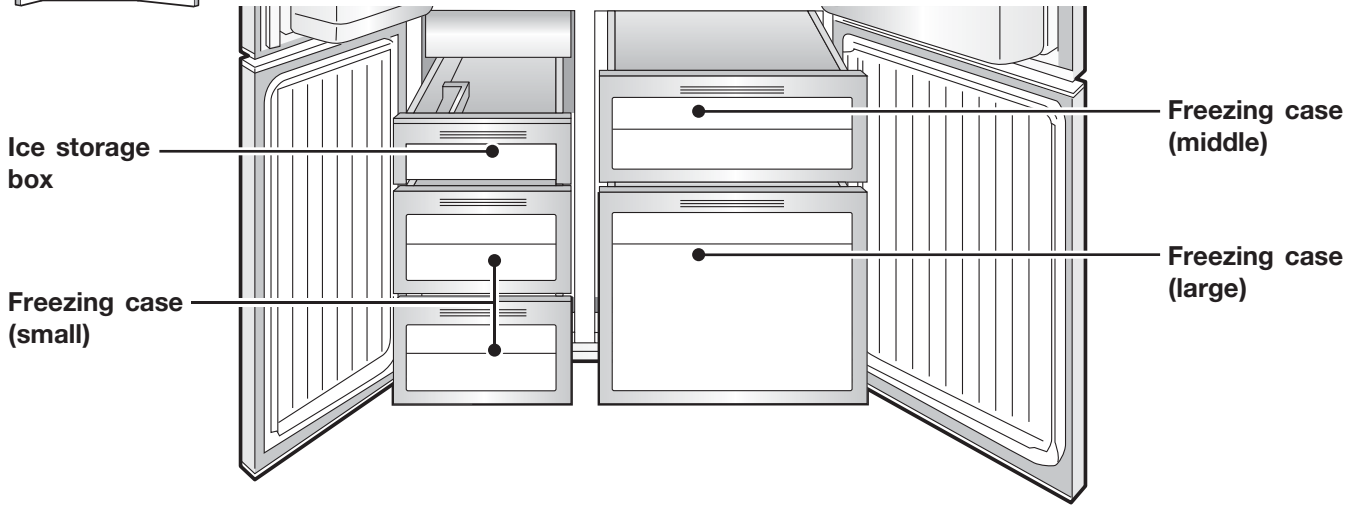

15 cm height of plastic bottles for freezing can be placed standing up in the Freezing case (large).

Ensure the bottles used are capable of being frozen without damage or leaking.

■ If the door alarm sounds ► **Page 22**

Do not place tall objects in the lower freezing case.

- Food or the slide case may be damaged.
- The door may not close.

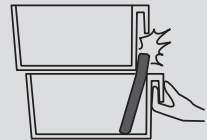



Automatic Ice-Maker

You can make ice cubes by putting water in the water supply tank of the refrigerator compartment. Please do periodically maintain to make a good ice cube by cleaning. Please drain the water in the water supply tank when you do not make ice.

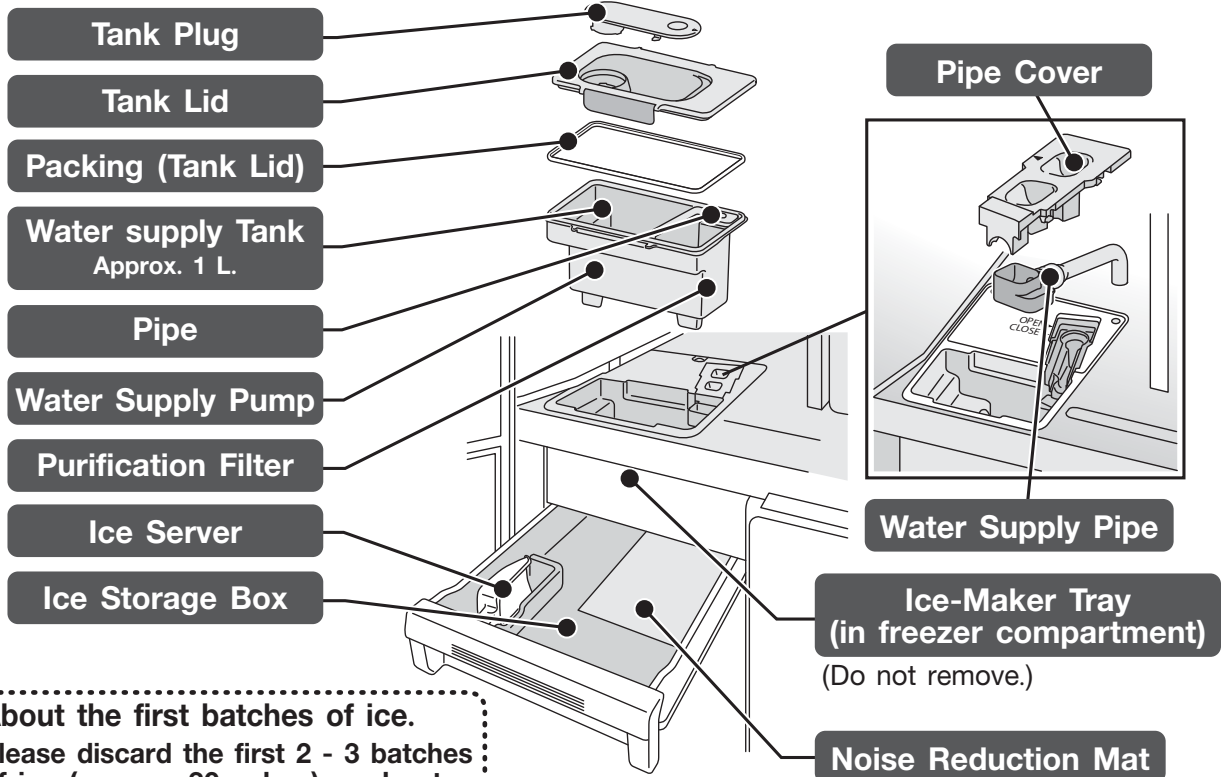

About the first batches of ice.
Please discard the first 2 - 3 batches of ice (approx. 30 cubes) made at the very beginning. Also, discard ice that isn't used in over 1 week. There may be times when there may be dust or an odor on them.

Water to Use for Your Auto Ice-Maker.
We recommend that you use water such as tap water which contains less bacteria. If you use mineral water or water from a filtering machine, please increase the number of cleaning times, and be sure to clean it thoroughly. → Page 19~20

Reduces noise of dropping ice
Do not remove.

Before use

Operation

Cleaning

When in trouble

How to make ice

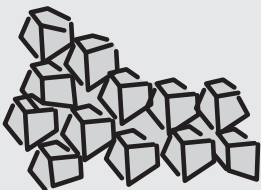

WARNING
Fill with potable water only.

1 Take out the water supply tank, remove the tank plug, and fill with water.
Fill water to the "full line" mark.

How to remove the tank plug.
Turn to the "Open" position and lift off.

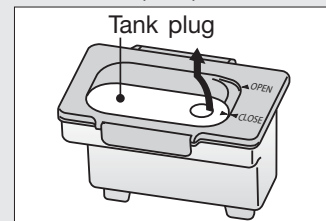



2 Put the tank plug on the water supply tank, carry carefully without tilting it, and return to its original position.

- When carrying the water supply tank, make sure that the "▶" symbol is in the closed position.
- If the tank is tilted, water will spill out.
- If the water supply tank is not properly in position, ice cannot be made. Make sure that there is nothing blocking the tank receiving area.

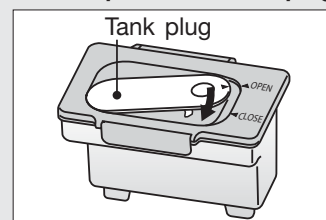
How to put in the tank plug.





To stop ice-making

- ① Touch  on the operation panel
- ② Touch 
- ③ Touch 

STOP ICE will light up
The setting is finished



To restart ice-making

- ① Touch  on the operation panel
- ② Touch 
- ③ Touch 

MAKE ICE will light up
The setting is finished





When you will not make ice for a long time ※Also do this when moving or transporting unit.

Empty the ice-making tray by taking out the ice or by forcing water to go into the ice storage box.

1 Take out the water supply tank, close the freezer door.





2 Press  for about 5 seconds. (Press until it makes a beeping sound.)

-  and  will blink for about 1 minute. (It drops down the ice-making tray's water or ice.)
- When the light stops blinking, it will return to the previous indication.

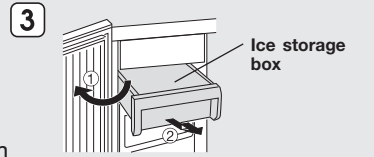
3 Take out the ice storage box. And discard water or ice.



4 Stop making ice.

- If  light is on, to do ice-making stop procedure and check to confirm that  light is on.

5 Wash with water, dry, and put back in place: the water supply pump, pipe, water filter, ice storage box and the noise reduction mat. → Page 19~20

To restart ice-making, to do ice-making restart procedure and check to confirm that  light is on.



Please note

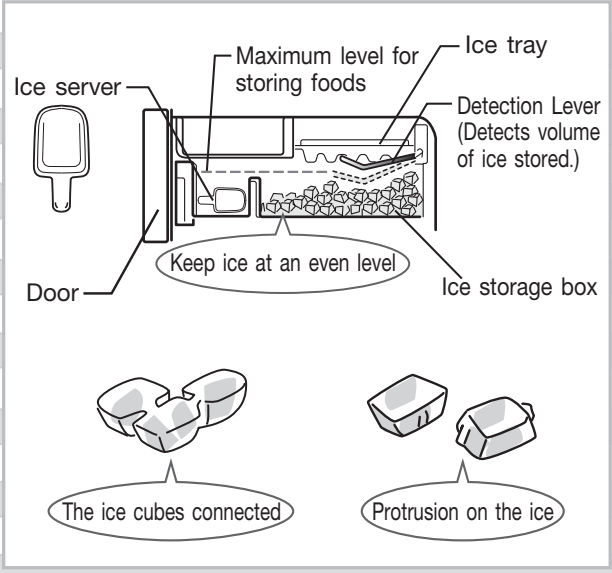

- Do not put the food items when making ice.
- Please do not store anything above the level on the side of the ice storage box. (The door may half-open and it may cause failure/damage).
- Do not insert any drinks such as hot water, juice, tea, soft drink, etc. other than water in water supply tank (heatproof temperature 60°C). It may cause failure.
- Ice-making will stop when the amount of storage ice is given quantity. Ice cube will flat when it thick some, please insert ice server horizontally in front side of ice storage corner as the left figure.
- Please gently close the door of freezing compartment. Ice cube may get dirty.
- Do not insert water over full water mark in water supply tank. Water channel in the ice tray may freeze, ice cube may connect together, and convex may come out, if insert water over the mark or pour water by kettle.

About the ice

- Ice made with water containing a lot of mineral substances such as mineral water, can cause to ice to form with a white sediment (white crystals). These are only mineral substances that have become crystallized. It is harmless.
- If ice is stored for a long period of time, the ice cubes may cling together or become smaller. (This is known as the phenomenon of sublimation.)



Please pay enough attention when crush the ice which stuck in ice storage corner.
It may cause injuries.

Rapid Cool (in refrigerator compartment)

When storing a large amount of food, protect the food's freshness by rapidly cooling it.

RAPID COOL

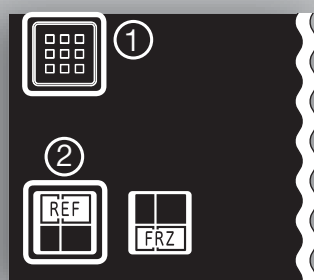

Swiftly cool refrigerator compartment when their doors are opened and closed

To Set

1 Touch  on the operation panel

2 Touch 
The text above the icon will light up.

3 Touch 
The settings are finished.

This ends automatically about 2 hours after setting.

It doesn't matter whether you put food in before or after turning on the settings.

To cancel the setting → Page 7

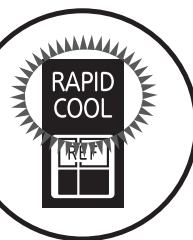

Before use

Operation

Cleaning

When in trouble

Notice

- The sound of the refrigerator running gets louder during Rapid Cool, because it is operating at high speed.

Rapid Freeze (in freezer compartment)

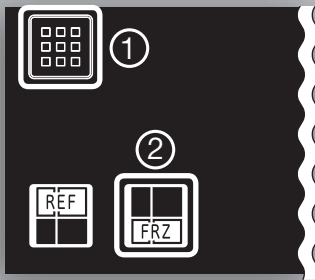

When storing a large amount of food, protect the food's freshness by rapidly freezing it.

RAPID FREEZE



Swiftly cool freezer compartment when their doors are opened and closed

To Set

- 1 Touch  on the operation panel
- 2 Touch  The text above the icon will light up.
- 3 Touch 

The settings are finished.

This ends automatically about 2 hours after setting.

It doesn't matter whether you put food in before or after turning on the settings.

To cancel the setting → Page 7



Notice

- The sound of the refrigerator running gets louder during Rapid Freeze, because it is operating at high speed.

Energy Saving Mode

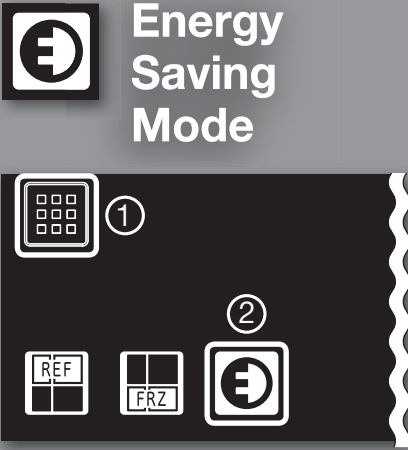

This mode learns each family's method of use and operates with the optimal state for each compartment.

Energy Saving Mode





An appropriate timing is selected for each compartment and the energy saving mode is performed automatically with a slightly high temperature setting.

To Set

- 1 Touch  on the operation panel
- 2 Touch  The text above the icon will light up.
- 3 Touch  The settings are finished.

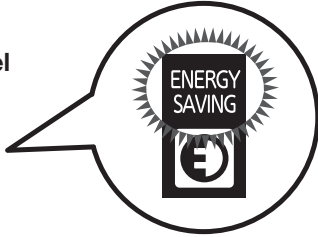
To cancel the setting → Page 7



If Energy Saving Mode is set,  is displayed.

If switched to power saving operation while Energy Saving Mode is set,  is displayed.

Tips for using the refrigerator wisely

Temperature settings

Setting each compartment to a relatively low operation reduces the consumption of electricity.

Opening and closing compartment doors

The refrigerator consumes more electricity if you open and close the compartment doors frequently or leave the doors open for a long time.

Energy Saving Mode

In this mode, the refrigerator automatically operates in an energy saving fashion when the temperatures are stable in the compartments. The refrigerator is not set in this mode when newly installed.

Storing foods

Do not fill any fridge compartments with too much food, or place food in a manner that blocks the cold air outlets. Blocking the cold air outlets will compromise the airflow which can cause some areas of the fridge to take longer to cool to the optimum temperature and reduce energy efficiency.

Lights-Out

In the following cases, energy saving mode will be cancelled and the light will turn off.

- When the doors are frequently opened and closed
- When Rapid Cool or Rapid Freeze is operating
- After defrosting

(After the freezer compartment is sufficiently cold and stable, energy saving mode will automatically restart.)

Before use

Operation

Cleaning

When in trouble

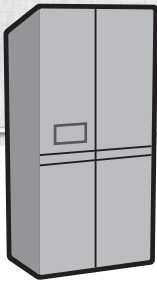

Detail Setting

Performing Temperature Adjustment

The temperature of each compartment can be adjusted.
Use the refrigerator and freezer to "COLD" usually.



Temperature Adjustment

At the time of purchase, the settings are as follows.

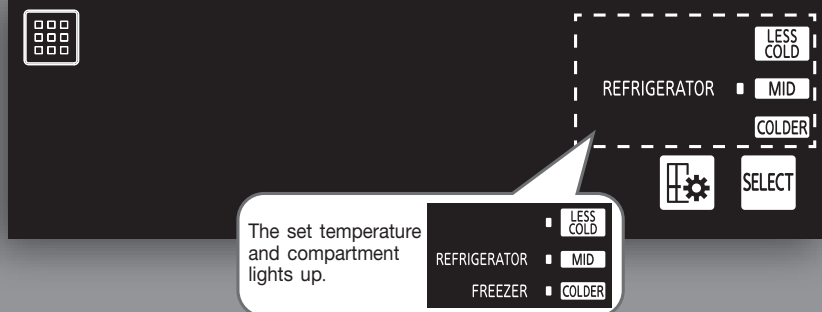
Refrigerator and Freezer Compartments
....."COLD"



The set temperature and compartment lights up.





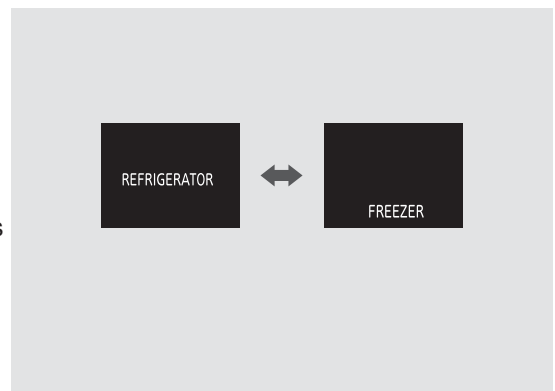









- 1 Touch  on the operation panel
- 2 Repeatedly touch  to light up the compartment that you want to set the temperature for.
The display changes in the order shown in the right each time the button is touched.
When a compartment is displayed, that compartment's temperature setting will also be displayed.
- 3 Repeatedly touch  to set the temperature.

In 2 and 3, touching  or not performing any operations for about 30 seconds will return the display to its initial state. → Page 7



Refrigerator/Freezer Compartment Temperature

The display changes each time  is touched and the temperature can be set to 5 different levels.

Compartment	REFRIGERATOR	FREEZER
  	About 6°C	About -16°C
  	About 5°C	About -17°C
  	About 3°C	About -19°C
  	About 1°C	About -21°C
  	About 0°C	About -22°C



Notice

- The temperatures described here are measured in the lower centre of the refrigerator after the temperature has stabilized when the surrounding temperature is 30°C and the doors are closed without any food inside. The temperature fluctuates with factors such as food storage conditions and how often the doors are opened and closed.
- Before and after defrosting, the temperature inside the refrigerator may drop or rise temporarily.
- When food freezes in the refrigerator compartment or lower case, set the refrigerator temperature setting to COLD - LESS COLD.

How to remove and clean accessories



Always unplug electrical plug from socket

Unplug the electrical plug.

If it is not unplugged, it will cause an electric shock.



Do not do

Do not take apart, repair or convert. Do not continue to use with damaged parts.

This can cause injury, an electric shock or a fire.

※ Wait 10 minutes or more before you replug the electrical plug into the outlet. If you plug it in immediately after unplugging it, the refrigerator will not run.

How to maintain Q&A



Q. If dirt is noticed.

A. Please wipe as soon as possible.

- Wipe with a soft towel soaked in warm water.
- For hard to remove dirt, please use a kitchen detergent (neutral type) and wipe off with water.
- In particular, oil may lead to cracks and citrus fruit juices to discoloration, so be sure to wipe them off right away.
- Door packing may cause damage or cold air leakage if you leave the dirt. Please wipe off the moisture with dry towel after wipe off with soft and soak towel.

Q. Can the shelf, case and pocket be removed?

A. For removable parts, please see → Page 18

Please take heed

● Do not use the following items.

Alkalinity or alkalescent kitchen detergent, undiluted neutral kitchen detergents, polishing powder, soap powder, alcohol, benzine, thinner, petroleum, acid, scrub brush, hot water, etc.

Plastic parts (door handle, cap, case, etc.) will crack, and glass shelf or painted surface may damage or rust.



Power Plug

For safety, please periodically check the power plug and cords.

- ① Unplug the electrical plug from the outlet and inspect.
- ② Is there any damage or abnormal heat coming from the plug or cord?
- ③ Wipe away dust from the plug and around the plug area with a dry cloth.
- ④ Insert the electrical plug fully into the outlet.

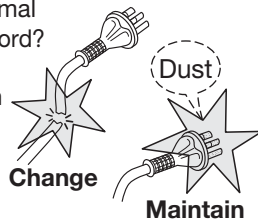

Always follow instructions

Wipe out the dust in power plug periodically.

It may cause fire or insulation failure.

Refrigerator rear side and floor

Dust and dirt can accumulate in the ventilation space behind the refrigerator. Please clean periodically for energy saving purposes.

- ① Remove the toe grille.
- ② Turn the adjustable supports to raise them from the floor, and pull out the refrigerator. **We recommend laying out protective material on the floor to prevent the floor from being damaged. Also, be careful not to injure yourself.**
- ③ Remove the dust from the rear panels, walls and floor, and wipe off any dirt.
- ④ Check for water dripping on the floor.

Soot and dust

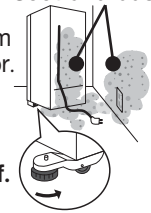

Do not do

Do not put your hands or feet under the refrigerator.

It may cause injury.

Replacing lamps in compartments

LEDs in the refrigerator compartments and behind of Vegetable case.

Contact the retail store at which you purchased this refrigerator from or MITSUBISHI ELECTRIC SERVICE CENTRE.

Before use

Operation

Cleaning

When in trouble

Use reverse procedures to put accessories back in place.

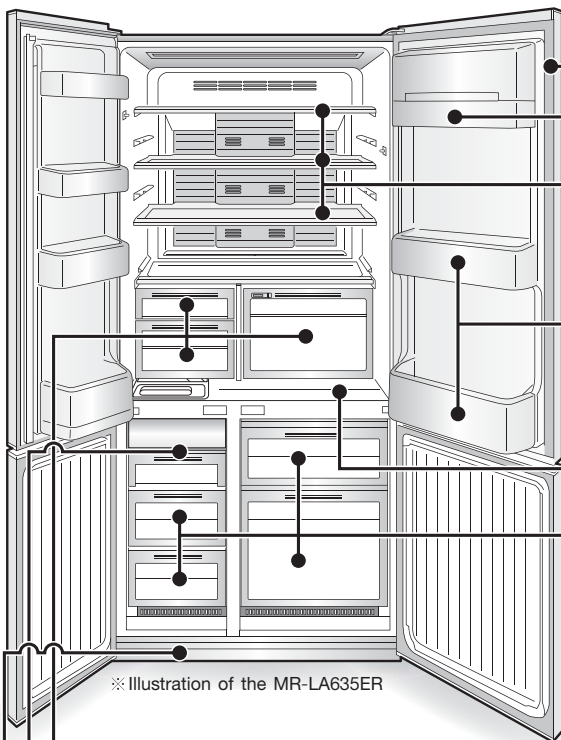

※ Illustration of the MR-LA635ER

Utility case / Vegetable case / Vegetable case cover

Utility case

- ① Fully pull out the slide case.
- ② Lift the end on your side.

Vegetable case

Lift the end on your side to pull out the Vegetable case.

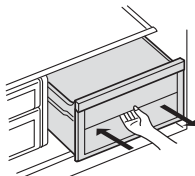

Vegetable case cover

- ① Slide the left side of cover to end.
- ② Push down the right side of cover.
- ③ Pull towards your side.

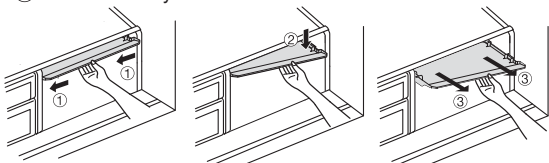

*The ceiling shelf on the upper side of cases cannot be removed.

Ice storage box

- ① Open the door.
- ② Draw the ice storage case towards you and remove.

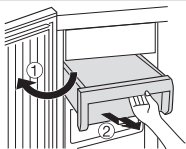

Support cover

- ① Remove by pulling forward on both sides.

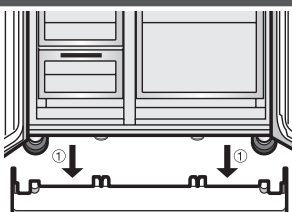

Door packing

Dirty packing is easily damaged and can cause refrigerated air to leak.



Tempered glass shelves

How to remove the upper shelf

Lift the upper shelf with both hands to take it out.

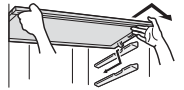

How to remove the middle and lower shelves

Remove the middle and lower shelves with both hands.



Reverse the steps to put back the shelves.

- Do not let the tempered glass shelves fall off.

Capsule door pocket

- ① Lift the cover by 100 degrees.
- ② Push the cover to one side and remove it while pushing in the rib of the hinge cover with your finger.
- ③ Remove the cover towards you.

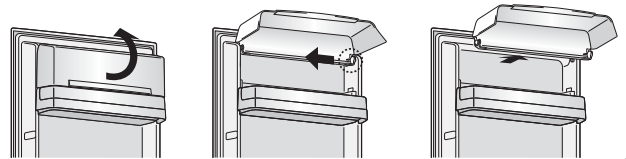

Adjustable pocket / Bottle pocket

Adjustable pocket

Bottle pocket

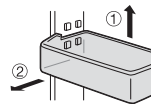

- ① Alternately lift up the left and right sides (the pockets are securely installed).
- ② Pull towards you.
- ③ Be sure to install the Adjustable pocket and the bottle pocket securely and correctly.
(Or else, the pocket may fall off, causing a personal injury.)

Cases in the Freezer compartment

Pull the case towards you. Hold the end on your side and lift the case.



Liquid-Catching indentations

Wipe away any dirt, liquid or condensation.

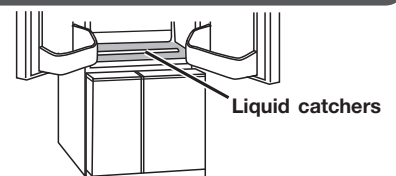

How to maintain your automatic ice-maker

Please periodically clean to prevent the occurrence of water scale, mold, etc. Please remove water when not making ice.

※ Do not use a dishwasher or dryer because it may cause deformation.

For once-a-week Water supply tank / Purification filter

If mold forms easily in the certain types of water, clean about 2 or 3 times a week.

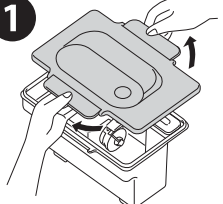
1  **Take off the lid and wash with water.**
(Temperature tolerance approx 60 °C)

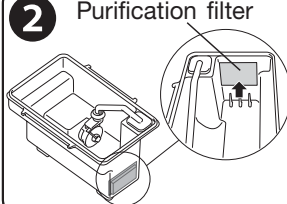
2  **Purification filter** **Remove and wash with water. Normally, it does not need replacing. Please replace for the following reasons:**

- If something other than water was put in and the opening got blocked.
- If it is damaged.
- If mold, etc. is forming.

To buy another filter, please inquire at the store where you bought your unit.

For once-a-month Water supply pump

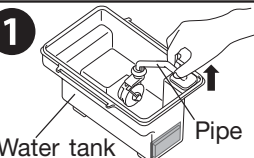
1  **Remove it from tank.**
Water tank Pipe

Pointers for assembling the water supply pump

If it is not assembled properly, it may not make ice or it may make a loud sound. Please check on the following.

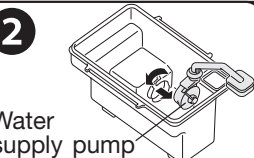
2  **Turn the pump and take out.**
Water supply pump

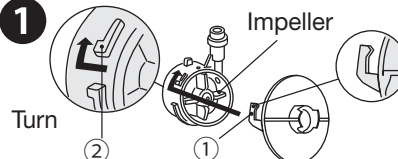
1  **Turn** **Impeller** **The claw on the cap (1) is turned to put onto the protruding part (2) of the water supply pump.**
※ Check to make sure that the impeller is inside.

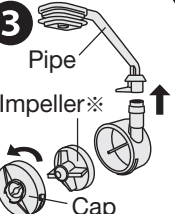
3  **Take out the pipe, Turn the cap and remove, Take out the impeller and wash with water.**
Pipe Impeller※ Cap
※ The impeller is made with a magnetic material. Clean thoroughly with water, making sure there are no substances on it.

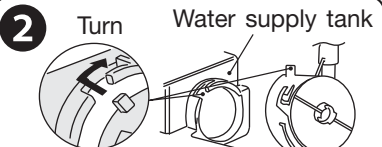
2  **Turn** **Water supply tank** **Attach the water supply pump properly to the water supply tank by turning and attaching.**

4 **Return parts by following the reverse procedure.**

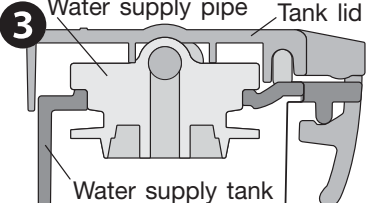
3  **Water supply pipe** **Tank lid** **Insert the water supply pipe into the water supply tank opening, Connect the pipe to the water supply pump.**
Water supply tank
※ Check to make sure that there are no substances at the connection point of the two pipes.

Before use

Operation

Cleaning

When in trouble

How to maintain your automatic ice-maker (Continued)

For once-a-month Water supply pipe

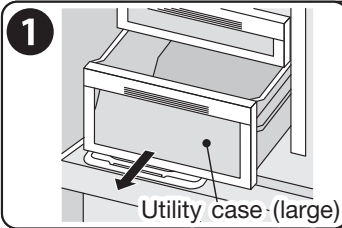

1 Fully pull out the slide case. Lift forward to remove.

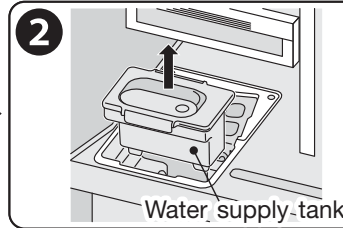

2 Take out the water supply tank.

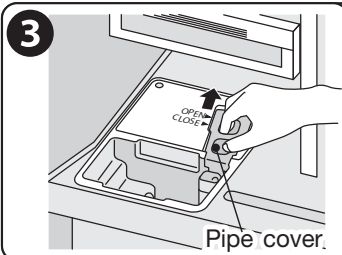

3 Slide the pipe cover to the "OPEN" position.

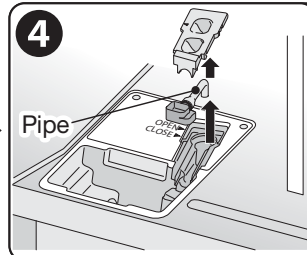

4 Remove the pipe cover. Remove the pipe. ✘

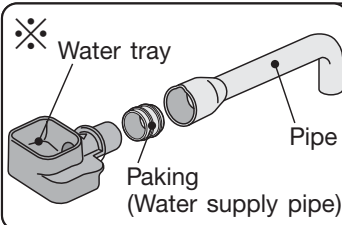

5 The water tray and pipe can be removed for cleaning.

5 After cleaning, return parts by following the reverse procedure.

NOTE

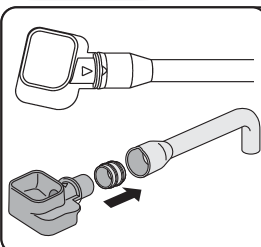

When assembling the water tray and the pipe, align the arrow on the water tray, the packing (Water supply pipe) with the convex shape of the pipe. If removal or assembly are not done correctly, a problem such as a water leakage will occur.

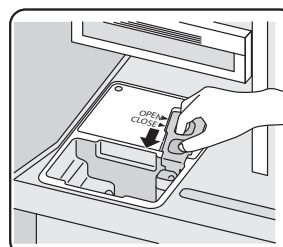

When installing the pipe cover, be sure to slide it to the "CLOSE" position. The pipe may come off.

Cleaning the ice-making tray (rinsing)

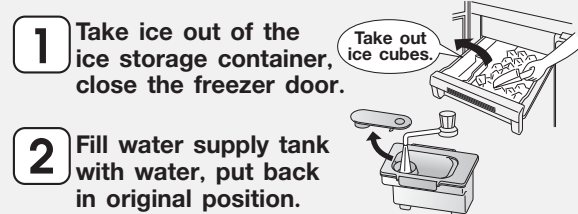

1 Take ice out of the ice storage container, close the freezer door.

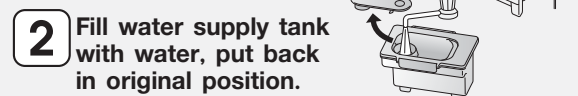

2 Fill water supply tank with water, put back in original position.

3 Touch for about 5 seconds. **MAKE ICE** and **STOP ICE** will blink for about 1 minute.
 ● The stop ice-maker light (red) will blink for about 1 minute. (It rinses the ice-maker tray with water from the water supply tank.)
 ● When light stops blinking, it will return to the previous indication.

4 Repeat **3** 2 or 3 times.

5 Remove the Freezing Case (upper) discard water and ice. Do not throw out noise reduction mat (same as p.11)

Notice

- Do not use washing agents such as kitchen detergents, benzene or bleach to clean the water filter. It will cause ice to have an odor.
- If you use a bleach to clean your water supply tank or lid, please follow product directions carefully.
- Assemble the water supply pump properly and firmly. If it is not assembled properly, it may not make ice or it may make a loud sound.
- Please attach the lid of water supply tank securely. If the lid is not attached properly, the lid may be out and the water supply tank will fall.

Other Issues (Power Outages, Child Safety Lock, Setting Reset, When **DEMO** Lights Up)

Power Outages

- Minimize the frequency of opening the doors, and avoid adding more food.
- Operation panel settings other than the temperature settings may change. Check the settings. (Child Safety Lock, etc.)

To Prevent Accidental Button Operation (Child Safety Lock)

Locks the operation panel to prevent accidental icon operation by children.

- 1 Touch  for about 5 seconds or more when the door is closed (until the buzzer sounds).

 lights up when the setting is finished.

- Setting cannot be changed during Child Safety Lock.



To Cancel

- 1 Again, touch  for about 5 seconds or more when the door is closed (until the buzzer sounds).

 goes off when the setting is cancelled.

To Reset Settings

Returns the settings to their initial conditions (at the time of purchase), for example if you have forgotten the settings.

- 1 Touch  to light up an icon.
- 2 Touch  for about 10 seconds (until the buzzer sounds twice).



The following settings will be reset.

- Rapid Cool  • Rapid Freeze  • Energy Saving Mode 

When **DEMO** Lights Up

When **DEMO** lights up, the refrigerator is in demonstration mode. The refrigerator does not cool in this mode. Contact the retail store where you purchased the refrigerator, or cancel the demonstration operation with the following procedure.

To Cancel

- 1 Keep the doors of the freezer compartment open.
- 2 Light up the icons and press , , and  at the same time for at least 5 seconds.
- 3 Check that **DEMO** is turned off.
 - The demonstration mode was not cancelled if it lights up.



Touch until the buzzer sounds

Before use

Operation

Cleaning

When in trouble

Other Issues (Door Alarm, Mark, When Not Using the Refrigerator for a Long Time)

When the Door Alarm Sounds and the Interior Light of the Refrigerator Compartment Blinks (Door Alarm)

The door alarm (with alarm sound, interior light, and compartment display) is activated when a door is open for 1 minute or longer.

The pattern of the door alarm sound and the action of the interior light and compartment display area are as follows depending on how long the door has been left open.

Time for which the door left open	1 minute	2 minutes	3 minutes	4 minutes	5 minutes or longer	60 minutes or longer
Alarm sound	4 short beeps, then 2 beeps	4 short beeps, then 3 long beeps	4 short beeps, then 4 long beeps	After 4 short beeps, Continuous long beeps	Continuous short beeps	
Interior light	On			Blinks twice per minute		Off
Compartment display area	The compartment display area will blink in synchronization with the alarm sound					



Compartment display area
(Operation panel)

Blinks in synchronization with the alarm sound.

- Check that the doors are not left ajar or do not have any food trapped (the packing, the back of the drawer cases). (Check at least once a month.)
- Refrigerator and Freezer doors have an opening and closing sensor.
- Check the refrigerator compartment door rotating partition. ➔ **Page 8**

When the Alarm Cannot be Turned Off

Check that there are no gaps between the door.

When the alarm cannot be turned off, there may be a malfunction and an inspection is required. Contact the retail store where you purchased the refrigerator.

To Stop the Alarm (Continuous Short Beeps)

The alarm can be temporarily stopped in the time before the refrigerator is repaired.

Press  for at least 5 seconds.

* If performing the above operation does not turn off the alarm, or the alarm periodically sounds, check peripheral machinery as well.

When the Mark Blinks Rapidly (About 5 Times per Second)

When the refrigerator will not cool, there may be a malfunction and an inspection is required.

Contact the retail store where you purchased the refrigerator.

When Not Using the Refrigerator for a Long Time (When the Power Plug Is Unplugged)

- 1 Remove the power plug.
- 2 Empty any water or ice from the ice storage box and clean.
- 3 Clean the interior of the refrigerator and open the doors for 2 to 3 days to dry the inside.

* If the refrigerator is not dried sufficiently, it may cause mold, odors, or refrigerant (gas) leaks due to condenser corrosion.

Other Issues (To Move or Transport the Refrigerator)

To Transport the Refrigerator

- 1 Empty any water or ice from the water supply tank and ice storage box. ➔ **Page 18**
- 2 Wear protective gear (gloves).
- 3 Remove the adjustable support cover, and then rotate and raise the adjustable supports. ➔ **Page 5**
- 4 Remove the power plug.
- 5 Lay towels under the drainage port and the lower rear edge of the refrigerator, and position a container or tray with a height of about 3 cm on the towels to collect the water.

* The towels prevent floor damage, and water from being spilled on the floor.

- 6 Tilt the refrigerator slowly to the rear by about 30 degrees, and drain the water from the evaporation tray via the drainage port on the lower rear side. (The evaporation tray is not visible from the outside.)

* Because the refrigerator is heavy, the work must be performed by at least 4 people.

* The work must not be performed by small children or people who are not capable of doing heavy work. Ask a specialist transportation company.

- 7 4 or more people should hold the hand-holds on the bottom and the upper part of the rear side and the hand-holds on the lower inside part of the front side and the upper side of the rear, and carry the refrigerator slowly.

- Do not lay down the refrigerator on its side. (The compressor may be damaged.)

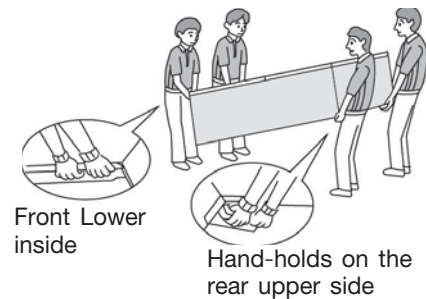
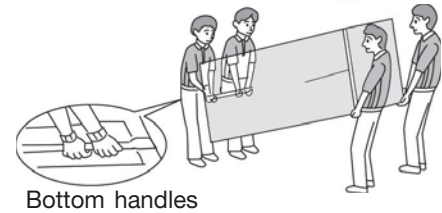
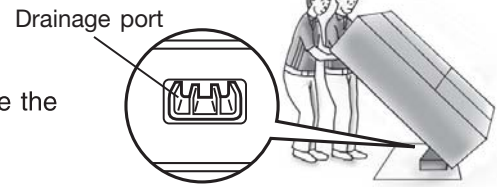

When the Transportation Time Is Long, for Example When Moving House

- Frost from the condenser inside the freezer compartment will melt, and may spill water when the refrigerator is transported. It may take 1 day to defrost after unplugging the power plug.



Do not damage the refrigerator's refrigerant circuit (pipes).
Because combustible refrigerant is used, this may result in fire or an explosion.

To Move the Refrigerator in Forward and Backward Directions

- 1 Remove the adjustable support cover, and then rotate and raise the adjustable supports cover. ➔ **Page 5**
- 2 Lay protective material under the casters and rear supports to prevent damaging the floor.
- 3 Move the refrigerator in the forward and backward directions.

* Moving in any direction other than forward and backward may damage the floor. Please make sure to lay protective material such as a plate or board on the floor.

Before use

Operation

Cleaning

When in trouble



Other Issues (Temperature Fine Adjustment Mode)

To Control the Temperature More Precisely (Temperature Fine Adjustment Mode)

The temperature can be set to 11 different levels for the refrigerator compartment and freezer compartment,

- When temperature fine adjustment mode is set, the compartment display blinks about every 10 seconds.

Setting the Temperature Fine Adjustment Mode



- 1 Touch  to light up icons.
- 2 Touch  and select the compartment you would like to set to temperature fine adjustment mode.
- 3 Touch  for at least 5 seconds (until the buzzer sounds).
 - The refrigerator compartment, freezer compartment, can all be set with a single operation.

To Cancel

The same operation as above.

- If the setting is reset, it will be cancelled.

Performing the Temperature Fine Adjustment

- 1 Touch  to light up icons.
- 2 Touch  to select the compartment to perform temperature fine adjustment.
- 3 Repeatedly touch  to perform temperature fine adjustment.

Display Example: When the refrigerator compartment is set to Temperature Setting 5.

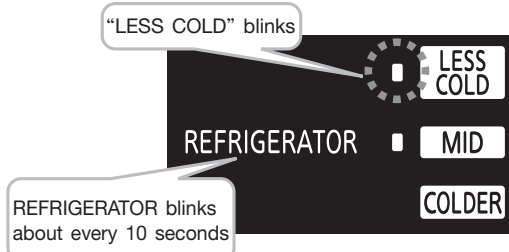

Refrigerator Compartment / Freezer Compartment

	Temperature setting
1	
2	
3	

4	
5	
6	

7	
8	
9	

10	
11	

*  represents a blinking display.

Troubleshooting

Before contacting MITSUBISHI ELECTRIC SERVICE CENTRE or its service agent or making a repair request, check the following.

If the problem persists, contact the retail store where you purchased the refrigerator as soon as possible.

Frequently asked questions in the initial period and in summer

The refrigerator does not cool at all!

- The refrigerator takes time to cool when you first start using it. In summer, it may take up to 24 hours for the inside to be fully cooled. → **Page 4**
- If **DEMO** is shown on the operation panel, cancel demonstration mode. → **Page 21**
- Check if the power plug is disconnected or the circuit breaker has tripped.

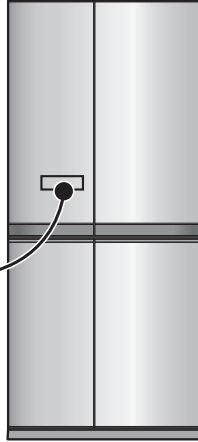

The operation panel turns off automatically!

- If 30 seconds pass without any operation panel button operations, the display turns off. When lighting, touch . → **Page 6**

The outer walls heat up!

- The outer walls heat up significantly (to about 50 to 60°C) immediately after installation and in summer. This is because the heat discharging and condensation prevention pipes are located on the sides and the top of the refrigerator. They are required for cooling and the heat is not an abnormality.
- The refrigerator compartment rotating partition also has a condensation prevention heater that heats up.
- A heat discharging fan is located under the refrigerator. Warm air may be discharged from here.

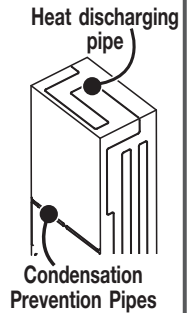

	Problem	Check	Explanation and Action
Cooling Performance	Does not cool well	① Has enough time passed after installation?	It takes 4 to 5 hours for the refrigerator to cool, and may take 24 hours in summer to fully cool.
	Not much ice is made Ice melts	② Is the temperature setting set to "LESS COLD"?	Set to "COLD or COLDER" or to the setting of your liking. → Page 16
		③ Is the flow of cold air being blocked? Are the doors being opened frequently, or left ajar? Is food blocking them?	Make space between foods and remove any food that is sticking out of shelves or touching the ceiling of the drawers. Avoid opening and shutting the door for a while.
		④ Is heat discharging being blocked? Check if there is no gap around the refrigerator and the refrigerator is exposed to direct sunlight.	Check that there is enough space around the refrigerator and that it is properly installed. → Page 4
		Food freezes in the refrigerator and vegetable compartments	① Is the temperature on the operation panel set to "COLDER"?
	② Is food with a lot of moisture stored at the rear of the shelf?		Place drinks and food containing a lot of water, such as tofu, vegetables and fruits, at the front of the shelf or in a door pocket.
③ Is the surrounding temperature 5°C or less?	Food in the refrigerator compartment or vegetable compartment may freeze. Freezing is less likely when the temperature settings are set to "LESS COLD". → Page 16		
Sound	There is a rattling sound	① Are any nearby objects in contact with the refrigerator?	Leave space around the refrigerator. When objects or walls are in contact with the refrigerator, sounds may be heard.
	Loud noises Worrisome noises (Noises described on the right are normal)	① The noise gets louder suddenly or the tone changes.	Immediately after beginning use, when the weather is hot, when the doors are frequently opened and closed, and in similar situations, the refrigerator switches to high-speed operation and cools with high power.
		② A whistling sound is made after closing a door.	This is the sound of the cooling fan motor starting.
		③ A whipping or dripping sound is sometimes heard from inside the refrigerator after a door is opened.	This is the creaking sound as warm air enters and expands the plastic.
④ Sometimes the sound of flowing or boiling water can be heard.		This is the sound of the refrigerant (gas) flowing.	
Door	Doors do not close Doors open easily	① Is a door making contact with food or a case? Is too much food packed inside?	Store food so that the door does not make contact with the food when closed. In the refrigerator compartment, store food on the shelves and in the drawer doors store food so that it does not make contact with the ceiling when doors are shut and opened.
		② Has food fallen behind a case in a drawer door, or is the power cord or another object trapped between the refrigerator and a door?	Remove any objects. Make sure that the door does not trap objects such as food, power cords or plastic bags.
		③ Is the refrigerator installed stably? Are the adjustable supports making contact with the floor?	Lower the adjustable supports to raise the front side slightly and make the doors easier to close. → Page 5
	The alarm will sound	① Check if the doors are closed.	Refer to "When the door alarm sounds" and "When the alarm cannot be turned off". → Page 22



Before use

Operation

Cleaning

When in trouble

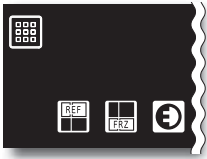
Troubleshooting (Continued)

	Problem	Check	Explanation and Action
Operation Panel	The operation panel does not respond 	① Is  lit?	Cancel the Child Safety Lock. ➔ Page 21
		② Are the user's fingers or the operation panel wet or dirty?	Wipe off the moisture and dirt on the operation panel and fingers.
③ Are you repeatedly touching it?		Let your finger off the operation panel once and then touch it again. It will respond when you let your finger off.	
④ Are seals and tapes put on the operation panel?		Remove the seals and tapes.	
	Reacts without a touch	① Are there any towels, plastic bags, papers, etc. over the operation panel?	Remove the towel, plastic bag, paper, etc.
Condensation/ Frost	Condensation forms on the outer walls and inside the refrigerator Frost forms in the freezer compartment Water drips onto the floor	① Are the doors being opened frequently, or are there any gaps?	Close the doors so that there are no gaps. When moisture in the air cools, it forms frost or condensation. When there is high humidity, condensation or frost will form even in very small gaps. Regarding the Vegetable Compartment. ➔ Page 8
		② Is the humidity high, for example is it raining?	Condensation may form temporarily. Wipe off with a dry cloth. Condensation may cause frost to form in the freezer compartment. Please minimize the time when doors are kept open.
Automatic Ice Making	Cannot make ice Water in the tank stays at the same level	① Has enough time passed after installation?	It takes 4 to 5 hours for the refrigerator to cool, and 24 hours or more in summer to make ice.
		② Has food, the ice server, or another object been left in the ice storage box? Also, has the ice been leveled?	Remove food or other objects from the ice storage box. The ice storage box is judged to be full of ice. Also, spread the ice out flat all the way to the front.
		③ Is the ice making setting for the ice making compartment set to "STOP ICE"?	Set the ice making compartment's setting to  . ➔ Page 12
		④ Is the water supply pipe installed correctly in the tank holder area?	Remove any foreign objects creating gaps and install the pipe so that it is not loose. ➔ Page 19~20
		⑤ Are the water supply pump and tank pipe installed correctly onto the water tank?	Check that they are correctly installed. In particular, ensure that the opening of the tank pipe inside the tank is installed firmly to the tank. ➔ Page 19~20
	Water tank or water supply pipe freezes	① Are the water supply pipe and water tank installed to the refrigerator without any gaps? Additionally, is the tank pipe installed to the water tank without any internal gaps?	Check the installation around the water tank. If there are gaps, the cold air may escape and water may freeze. ➔ Page 19~20
	Ice is small or joined together	① Has ice been stored inside the ice storage box for a long time?	Ice stored inside the ice storage box for a long time may shrink or join together (due to a phenomenon called sublimation). When not using ice, it is recommended that you remove the water and stop the ice making.
Others	There are lines like scratches on the clear parts	① Is it a thin line without level difference on its both sides?	This is a mark created at the time the plastic is molded. It is created at the joint where resin flows. This is not a flaw.
	There are holes in the door and the refrigerator walls	① Are there small holes in the door or in the refrigerator walls?	These are holes that let air escape for the injection of foam heat insulating materials in the manufacturing process. These are not flaws or abnormalities.
	The surface of the sides or doors is warped	① Does the light reflected on the surface appear distorted?	Warping and surface waviness occurs in the manufacturing process. When light hits the surface, it may appear warped, but this is not an abnormality.
	Noise interferes with televisions or other devices	① Is the refrigerator installed near an electronic device such as a television?	Install the refrigerator away from electronic devices such as televisions.
		② Is the power to the refrigerator supplied from a socket near the entry hole of the antenna cable?	Use separate power. When using a 2 pin plug, use grounding.
	There is a bothersome smell (Food / Ice)	① Have you placed food with strong odor inside the refrigerator without sealing it in a container?	Store food with strong odor in packaging. The odor may not be removed with a deodorizing apparatus.

Accessories

	Model	MR-LA580ER	MR-LA635ER
	Accessories	Quantity	Quantity
Refrigerator Compartment	Tempered glass shelf (small)	1	1
	Tempered glass shelf (large)	1	2
	Utility case (small)	1	1
	Utility case (large)	1	1
	Vegetable case	1	1
	Adjustable pocket	1	-
	Door pocket (small)	-	1
	Adjustable pocket (small)	-	1
	Door pocket	1	1
	Bottle pocket (small)	1	1
	Capsule door pocket	1	1
	Door pocket (large)	1	-
	Adjustable pocket (large)	-	1
	Egg shelf	1	1
	Bottle pocket (large)	1	1
	Water supply tank (including purification filter)	1	1
Freezer Compartment	Ice storage box	1	1
	Noise reduction mat	1	1
	Ice server	1	1
	Freezing case (small)	2	2
	Freezing case (middle)	1	1
	Freezing case (large)	1	1
	Support cover	1	1

■ This appliance is designed for use in Australia and New Zealand only and cannot be used in any other country. No service is available outside of Australia and New Zealand."

MODEL NAME	COUNTRY NAME
MR-LA580ER/LA635ER-A	AUSTRALIA / NEW ZEALAND

CAUTION

1. This appliance is designed for use in ambient temperature listed below.

MODEL NAME	AMBIENT TEMPERATURE RANGE	CLIMATIC CLASS
MR-LA580ER, LA635ER-A	16 °C ~ 43 °C	T

The internal temperatures could be affected by such factors as the location of the refrigerating appliance, ambient temperature and the frequency of door opening, and, if appropriate, a warning that the setting of any temperature control device might have to be varied to allow for these factors.

2. A rise in temperature of the frozen food during manual defrosting, maintenance or cleaning could shorten the storage life.
3. Food to be frozen is not to be placed in direct contact with food in storage and, if appropriate, that it could be necessary to reduce the quantity to be frozen if freezing every day is anticipated.
4. The electrical power failure for 1-2 hour will only slightly affect the inside temperature. However, opening and closing the door results in temperature loss. In case there is more than 24 hours electrical power failure, the food should be taken out from the fridge.
5. In case you are leaving or there is no food in the fridge for more than 3 weeks, The fridge should be unplugged and cleaned.

Before use

Operation

Cleaning

When in trouble

- The appliance is not intended for use by young children or infirm persons without supervision.
- Young children should be supervised to ensure that they do not play with the appliance.
- **WARNING** - Do not use mechanical devices or other means to accelerate the defrosting process, other than those recommended by the manufacturer.
- **WARNING** - Do not use electrical appliances inside the food storage compartments of the appliance, unless they are of the type recommended by the manufacturer.
- **WARNING** - Just in case of having damaged the refrigerant circuit, do not use electric items or fire equipments near by, and open the window to ventilate the room. And contact the retail store at which you purchased it or the following MITSUBISHI SERVICE CENTRE.
- **WARNING** - When positioning the appliance, ensure the supply cord is not trapped or damaged.
- **WARNING** - Do not locate multiple portable socket-outlets or portable power supplies at the rear of the appliance.
- The refrigerator contains flammable refrigerant (R600a: iso-butane).
- The refrigeration system behind and inside the refrigerator contains refrigerant. Do not allow any sharp objects to come into contact with the refrigeration system.
- Do not block the openings on the circumstances of the refrigerator.
- The user manual should be handed over to any person who would use or handle the refrigerator whenever the refrigerator would be transferred to another location and delivered to a recycling plant.
- This refrigerator uses flammable foaming gas for insulation. Please deliver the unit to specialized industrial waste dealer when you do away it. Please follow the rules in your country.
- Do not store explosive substances such as aerosol cans with a flammable propellant in this appliance.
- This appliance is intended to be used in household application only.

R600a Refrigerant Warning

- This appliance contains a small quantity of R600a refrigerant which is flammable.
- During transportation and installation, ensure that the tubing of the refrigerant circuit is not damaged.
- Leaking refrigerant can ignite and may damage the eyes.
- In the event any damage does occur, avoid exposure to open fires and any device which creates a spark. Disconnect the appliance from the mains power.
- Thoroughly ventilate the room in which the appliance is located for several minutes.
- Notify Mitsubishi Electric Australia Pty Ltd. for necessary action and advice.
- The room for installing the appliance must be at least 1 cubic metre per 8 grams of refrigerant. The refrigerant quantity contained in this appliance is noted on the Rating Label of the appliance.
- If your Mitsubishi Electric Refrigerator should require service, please contact Mitsubishi Electric Australia Pty Ltd see back page of this user manual for contact details.

NOTE: MITSUBISHI ELECTRIC AUSTRALIA PTY LTD. DO NOT ALLOW SERVICE TO THE REFRIGERATION CIRCUIT OF THIS APPLIANCE.



If an abnormality or malfunction occurs, stop operation immediately and contact the retail store where you purchased the refrigerator or MITSUBISHI ELECTRIC SERVICE CENTRE or its service agent.

**SOLE AGENT in Australia
MITSUBISHI ELECTRIC AUSTRALIA PTY LTD.**

(Incorporated in New South Wales) ABN 58 001 215 792

348 Victoria Road, Rydalmere NSW 2116

For more information and support contact

www.mitsubishielectric.com.au

Call 1300 651 808

**SOLE AGENT in New Zealand
BLACK DIAMOND TECHNOLOGIES LIMITED (BDT)**

Wellington Office (Head Office)

1 Parliament Street Lower Hutt PO Box 30772 Phone: (04) 560 9147, Fax: (04) 560 9133

Auckland Office

Unit 1, 4 Walls Road Penrose PO Box 12726 Phone: (09) 526 9347, Fax: (09) 526 9348

Christchurch Office

44 Halwyn Drive Hornby PO Box 16904 Phone: (03) 341 2837, Fax: (03) 341 2838

MITSUBISHI ELECTRIC CORPORATION

NZ79C925H01